

UAA-10077

[LLTH: UAA-10076]

Atlantic 1 Bollard



41w COB - (2075 - 2133) Lm | 29w COB - (1497 - 1508) Lm
 IP65 • Suitable For Wet Locations
 IK08 • Impact Resistant (Vandal Resistant)
 Weight 15 lbs

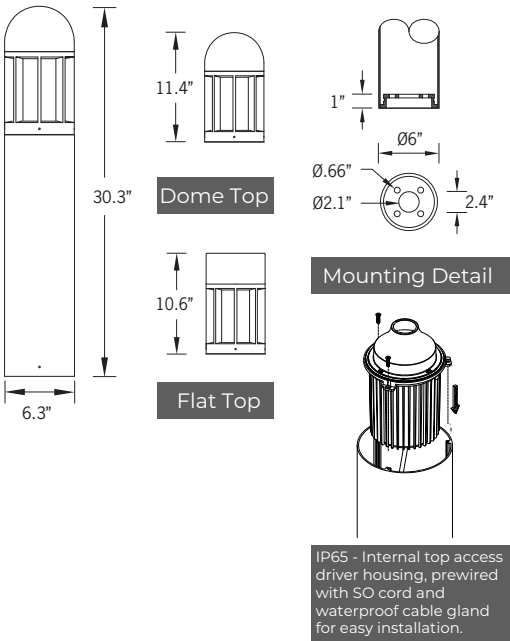

Construction

Aluminum
 Less than 0.1% copper content – Marine Grade 6060 extruded & LM6 Aluminum High Pressure die casting provides excellent mechanical strength, clean detailed product lines and excellent heat dissipation.

Pre paint
 8 step decrease and phosphate process that includes deoxidizing and etching as well as a zinc and nickel phosphate process before product painting.

Memory Retentive -Silicon Gasket
 Provided with special injection molded "fit for purpose" long life high temperature memory retentive silicon gaskets. Maintains the gaskets exact profile and seal over years of use and compression.

Thermal management
 LM6 Aluminum is used for its excellent mechanical strength and thermal dissipation properties in low and high ambient temperatures. The superior thermal heat sink design by Ligman used in conjunction with the driver, controls thermals below critical temperature range to ensure maximum luminous flux output, as well as providing long LED service life and ensuring less than 10% lumen depreciation at 50,000 hours.

Surge Suppression
 Standard 10kv surge suppressor provided with all fixtures.

BUG Rating
 B1 - U3 - G1 [W30] • B1 - U4 - G1 [W40]

Finishing
 All Ligman products go through an extensive finishing process that includes fettling to improve paint adherence.

Paint
 UV Stabilized 4.9Mil thick powder coat paint and baked at 200 Deg C. This process ensures that Ligman products can withstand harsh environments. Rated for use in natatoriums.

MicroPRIM Finishes
 MicroPRIM is Ligman's trade marked decorative powder coating technology that permanently infuses colors, patterns, or imagery directly into the surface of luminaires and poles while providing protections that standard powder coating does not offer.

MicroPRIM finishes include nature-inspired wood grains and stone aesthetics, material-inspired finishes such as brushed metal, concrete, and carbon fiber, Solid colors in Ligman standard colors, as well as any RAL or Pantone color, Decorative patterns, custom imagery and more.

Coating and Infusion Process

Metal components are pre-treated and powder coated with a proprietary polyurethane-based coating engineered for outdoor architectural use. Decorative patterns or imagery are then permanently infused into the cured powder coat through a heat-based process, creating a durable, integrated finish.

Performance and Validation

MicroPRIM finishes are suitable for indoor and outdoor applications and meet AAMA2605 architectural coating requirements. Performance is validated through laboratory and real-world testing to ASTM standards for UV exposure, adhesion, abrasion, impact, salt spray, chemical resistance, and graffiti resistance.

All MicroPRIM finishes are backed by Ligman's 10-year warranty.

- Key Performance Attributes**
- Anti-graffiti resistance
 - UV and weather resistance
 - Scratch and abrasion resistance
 - Natatorium Rated for installation in corrosive environments

Hardware

Provided Hardware is Marine grade 316 Stainless steel.

Anti Seize Screw Holes

Tapped holes are infused with a special anti seize compound designed to prevent seizure of threaded connections, due to electrolysis from heat, corrosive atmospheres and moisture.

Opal Borosilicate Glass Lens

Provided with opal borosilicate impact resistant glass.

Optics & LED

Precise optic design provides exceptional light control and precise distribution of light.
 LED CRI > 80

Lumen - Maintenance Life

L80 /B10 at 50,000 hours (This means that at least 90% of the LED still achieve 80% of their original flux)

Classic urban neighborhood bollard luminaire family. Timeless lines coupled with unparalleled build quality, flexibility and performance.

A decorative bollard with a symmetrical light distribution. Developed to complement the Atlantic range of pillar lights, post top and wall light luminaires. Designed for various applications including entrances, gardens, precincts and pathways.

Low copper content corrosion resistant extruded die-cast aluminum column. 316 Stainless steel hardware, durable silicone rubber gasket and impact resistant tempered opal diffuser. The luminaire is treated with a chemical nickel and zinc phosphate protection before powder coating (4.9 mil thickness), ensuring high corrosion resistance. Integral control gear.

This fixture is provided with an integrated waterproof driver box at the top of the bollard that ensures that the electrical components are protected from water and dust. This fixture is prewired to the base of the bollard facilitated easy electrical connections onsite. A laser cut anchor bolt template is provided for accurate anchor bolt installation. Options of house side shields and GFCI boxes are available. Please contact the factory for more information.

Additional Options (Consult Factory For Pricing)

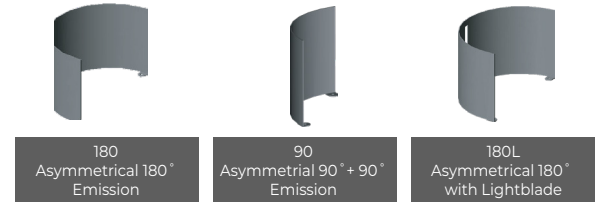

A91591
 Lockable In Use GFCI
 Receptacle Outlet Box



PROJECT		DATE	
---------	--	------	--

QUANTITY		TYPE		NOTE	
----------	--	------	--	------	--

ORDERING EXAMPLE || UAA - 10077 - 41w - 1 - W30 - 02 - 120/277v - Options

UAA-10077	LAMP	TOP	LED COLOR	FINISH COLOR	VOLTAGE
	41w COB 1454 Lumens	1 - Dome Top 	W27 - 2700K W30 - 3000K W35 - 3500K W40 - 4000K	01 - BLACK RAL 9011  02 - DARK GREY RAL 7043  03 - WHITE RAL 9003  04 - METALLIC SILVER RAL 9006  05 - MATTE SILVER RAL 9006  06 - LIGMAN BRONZE  07 - CUSTOM RAL 	120/277v
	29w COB 1028 Lumens	2 - Flat Top 			

--	--	--

ADDITIONAL OPTIONS

- DIM - 0-10v Dimming
- NAT - Natatorium Rated
- GFCI - GFCI Box
- HGT - Custom Height (SPECIFY HEIGHT)
- 180 - 180° Emission
- 90 - 90° + 90° Emission
- 180L - 180° Emission w/ Lightblade
- A91591 - Lockable In Use GFCI Receptacle Outlet Box



A91591
Lockable In Use GFCI
Receptacle Outlet Box

















More Custom Finishes Available Upon Request

Consult factory for pricing and lead times

MicroPRIM FINISHES

-  SW01 - OAK FINISH
-  SW02 - WALNUT FINISH
-  SW03 - PINE FINISH
-  DF - DOUGLAS FIR FINISH
-  CW - CHERRY WOOD FINISH
-  NW - NATIONAL WALNUT FINISH
-  SU01 - CONCRETE FINISH
-  SU02 - SOFTSCAPE FINISH
-  SU03 - STONE FINISH
-  SU04 - CORTEN FINISH
-  CSM - Custom Image/Pattern

MicroPRIM FINISHES

-  MP - MAPLE FINISH
-  MHG - MAHOGANY FINISH
-  BH - BEECH FINISH
-  CN - CHESTNUT FINISH
-  WMBL - WHITE MARBLE FINISH
-  MBL - MARBLE FINISH
-  GRNT - GRANITE FINISH
-  BGD - BRUSHED GOLD FINISH
-  BBRZ - BRUSHED BRONZE FINISH
-  CAMO - CAMOUFLAGE FINISH
-  MP01 - MicroPRIM RAL 9011 Black (Glossy)
-  MP02 - MicroPRIM RAL 7043 Dark Grey (Glossy)
-  MP03 - MicroPRIM RAL 9003 White (Glossy)
-  MP04 - MicroPRIM RAL 9006 Metallic Silver (Glossy)
-  MP05 - MicroPRIM RAL 9006 Matte Silver (Matte/Textured)
-  MP06 - MicroPRIM Ligman Bronze (Glossy)
-  MP07 - MicroPRIM Custom Color (Glossy)



Example: MicroPRIM Finish



Atlantic Product Family



Atlantic 1

- UAA-10076-41w-1454lm [Ø6.3"- 30.3"/29.6"]
- UAA-10086-41w-1454lm [Ø6.3"- 19.6"/18.8"]
- UAA-70077-41w-1454lm [Ø6.3"- 42.4"/41.6"]



Atlantic 2

- UAA-10096-41w-1602lm [Ø7.3"- 32.6"/31.3"]
- UAA-10106-41w-1602lm [Ø7.3"- 44.6"/43.3"]
- UAA-70087-41w-1602lm [Ø7.3"- 21.9"/20.6"]



Atlantic 3

- UAA-20046-29w-1105lm



Atlantic 4

- UAA-20076-41w-2632lm



Atlantic 5

- UAA-20166-41w-2632lm



Atlantic 7

- UAA-30146-29w-1105lm



Atlantic 8

- UAA-30156-41w-2632lm



Atlantic 9

- UAA-30186-41w-2632lm



Atlantic 13

- UAA-95016-41w-2632lm