

ULD-20013

Lador 15 Square Steel Cluster Column

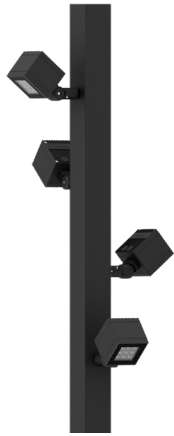

4x21w LED - 4 x 2,364 Lumens
IP65 - Suitable For Wet Locations
IK08 - Impact Resistant (Vandal Resistant)
EPA - 1.146m² → 12.34 ft²
Weight 58.2 lbs

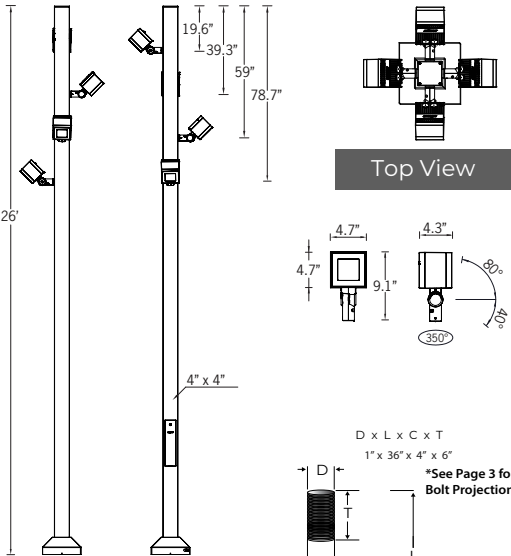

Poles are rated for 100 mph wind load. For geographical areas with higher wind speeds, please contact Ligman.

Mounting Detail

CITY OF FLAGSTAFF & TURTLE FRIENDLY COMPLIANT

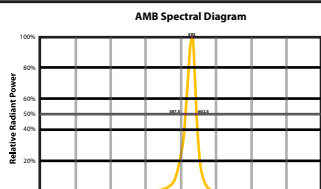

Narrow-Spectrum Amber LEDs

Peak wavelength between 585 & 595 nanometers and a full width of 50% power no greater than 15 nanometers.

Construction

Aluminum

Less than 0.1% copper content - Marine Grade 6060 extruded & LM6 Aluminum High Pressure die casting provides excellent mechanical strength, clean detailed product lines and excellent heat dissipation.

Pre paint

8 step degrease and phosphate process that includes deoxidizing and etching as well as a zinc and nickel phosphate process before product painting.

Memory Retentive - Silicon Gasket

Provided with special injection molded "fit for purpose" long life high temperature memory retentive silicon gaskets. Maintains the gaskets exact profile and seal over years of use and compression.

Thermal management

LM6 Aluminum is used for its excellent mechanical strength and thermal dissipation properties in low and high ambient temperatures. The superior thermal heat sink design by Ligman used in conjunction with the driver, controls thermals below critical temperature range to ensure maximum luminous flux output, as well as providing long LED service life and ensuring less than 10% lumen depreciation at 50,000 hours.

Surge Suppression

Standard 10kv surge suppressor provided with all fixtures.

BUG Rating

Contact Factory

Finishing

All Ligman products go through an extensive finishing process that includes fettling to improve paint adherence.

Paint

UV Stabilized 4.9Mil thick powder coat paint and baked at 200 Deg C. This process ensures that Ligman products can withstand harsh environments. Rated for use in natatoriums.

MicroPRIM Finishes

MicroPRIM is Ligman's trade marked decorative powder coating technology that permanently infuses colors, patterns, or imagery directly into the surface of luminaires and poles while providing protections that standard powder coating does not offer.

MicroPRIM finishes include nature-inspired wood grains and stone aesthetics, material-inspired finishes such as brushed metal, concrete, and carbon fiber, Solid colors in Ligman standard colors, as well as any RAL or Pantone color, Decorative patterns, custom imagery and more.

Coating and Infusion Process

Metal components are pre-treated and powder coated with a proprietary polyurethane-based coating engineered for outdoor architectural use. Decorative patterns or imagery are then permanently infused into the cured powder coat through a heat-based process, creating a durable, integrated finish.

Performance and Validation

MicroPRIM finishes are suitable for indoor and outdoor applications and meet AAMA2605 architectural coating requirements. Performance is validated through laboratory and real-world testing to ASTM standards for UV exposure, adhesion, abrasion, impact, salt spray, chemical resistance, and graffiti resistance.

All MicroPRIM finishes are backed by Ligman's 10-year warranty.

Key Performance Attributes

- Anti-graffiti resistance
- UV and weather resistance
- Scratch and abrasion resistance
- Natatorium Rated for installation in corrosive environments

Hardware

Provided Hardware is Marine grade 316 Stainless steel.

Anti Seize Screw Holes

Tapped holes are infused with a special anti seize compound designed to prevent seizure of threaded connections, due to electrolysis from heat, corrosive atmospheres and moisture.

Crystal Clear Low Iron Glass Lens

Provided with tempered, impact resistant crystal clear low iron glass ensuring no green glass tinge.

Optics & LED

Precise optic design provides exceptional light control and precise distribution of light.
LED CRI > 80

Lumen - Maintenance Life

L80 /B10 at 50,000 hours (This means that at least 90% of the LED still achieve 80% of their original flux)

Adjustable column architectural cluster solution. Flexible project solutions in attractive cluster arrangements using the square-form architectural Lador spotlight range.

A range of square outdoor IP66 floodlight projectors that meets both aesthetic and functional applications. This cubic cluster range is available with 2 different size floodlights. A 4.7" square profile at 21w and 5.7" square at 39w. This glare free luminaire is available in Narrow 10° beam, Medium 19°, Wide 33°, Very Wide 71° and Elliptical 41°x14° beam patterns.

This luminaire is engineered to meet harsh outdoor environments, as well as being able to be used as a decorative indoor product.

The Lador is provided with an integral driver and has accessories that include; dichroic color filters, linear spread lens, honeycomb louvres and anti-glare visors.

This floodlight also has a unique aiming and locking system for precise mounting and beam aiming.

The Lador product family consists of; floodlights, wall sconces, ceiling mounted squares and cluster column event poles.

This luminaire is available with a natatorium rated coating.

- ULD-20011 - 13 foot Aluminum (4.7" Flood)
- ULD-20021 - 13 foot Aluminum (5.7" Flood)
- ULD-20012 - 20 feet Aluminum (4.7" Flood)
- ULD-20022 - 20 feet Aluminum (5.7" Flood)
- ULD-20013 - 26 feet Steel (4.7" Flood)
- ULD-20023 - 26 feet Steel (5.7" Flood)

Additional Options (Consult Factory For Pricing)

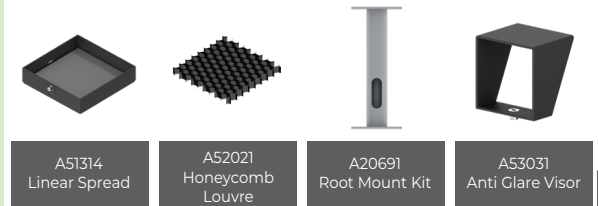

Dichroic Color Filters



ULD-20013

Lador 15 Square Steel Cluster Column

PROJECT	<input type="text"/>	DATE	<input type="text"/>
----------------	----------------------	-------------	----------------------

QUANTITY	<input type="text"/>	TYPE	<input type="text"/>	NOTE	<input type="text"/>
-----------------	----------------------	-------------	----------------------	-------------	----------------------

ORDERING EXAMPLE || ULD - 20013 - 4x21w - M - W30 - 02 - 120/277v - Options

ULD-20013	<input type="text"/>	<input type="text"/>	<input type="text"/>	<input type="text"/>	<input type="text"/>
	LAMP	BEAM	LED COLOR	FINISH COLOR	VOLTAGE
	4 x 21w LED 4 x 2,364 Lumens	N - Narrow 10° M - Medium 19° W - Wide 33° VW - Very Wide 71° E - Elliptical 41° x 14°	W27 - 2700K W30 - 3000K W35 - 3500K W40 - 4000K AMB - TURTLE FRIENDLY Amber LED 	01 - BLACK RAL 9011 02 - DARK GREY RAL 7043 03 - WHITE RAL 9003 04 - METALLIC SILVER RAL 9006 05 - MATTE SILVER RAL 9006 06 - LIGMAN BRONZE 07 - CUSTOM RAL	120/277v

<input type="text"/>	<input type="text"/>	<input type="text"/>	<input type="text"/>
----------------------	----------------------	----------------------	----------------------

ADDITIONAL OPTIONS

- | | |
|-------------------------------------|-----------------------------|
| DIM - 0-10v Dimming | A52021 - Honeycomb Louvre |
| NAT - Natatorium Rated | A20691 - Root Mount Kit |
| F - Frosted Lens | A53031 - Anti Glare Visor |
| CSA - CSA Rated Approved for Canada | A51314 - Linear Spread Lens |
- Max Height for CSA is 26FT*



















More Custom Finishes Available Upon Request

Consult factory for pricing and lead times

MicroPRIM FINISHES

-  SW01 - OAK FINISH
-  SW02 - WALNUT FINISH
-  SW03- PINE FINISH
-  DF - DOUGLAS FIR FINISH
-  CW - CHERRY WOOD FINISH
-  NW - NATIONAL WALNUT FINISH
-  SU01 - CONCRETE FINISH
-  SU02 - SOFTSCAPE FINISH
-  SU03 - STONE FINISH
-  SU04 - CORTEN FINISH
-  CSM - Custom Image/Pattern

MicroPRIM FINISHES

-  MP - MAPLE FINISH
-  MHG - MAHOGANY FINISH
-  BH - BEECH FINISH
-  CN - CHESTNUT FINISH
-  WMBL - WHITE MARBLE FINISH
-  MBL - MARBLE FINISH
-  GRNT - GRANITE FINISH
-  BGD - BRUSHED GOLD FINISH
-  BBRZ - BRUSHED BRONZE FINISH
-  CAMO - CAMOUFLAGE FINISH
-  MP01 - MicroPRIM RAL 9011 Black (Glossy)
-  MP02 - MicroPRIM RAL 7043 Dark Grey (Glossy)
-  MP03 - MicroPRIM RAL 9003 White (Glossy)
-  MP04 - MicroPRIM RAL 9006 Metallic Silver (Glossy)
-  MP05 - MicroPRIM RAL 9006 Matte Silver (Matte/Textured)
-  MP06 - MicroPRIM Ligman Bronze (Glossy)
-  MP07 - MicroPRIM Custom Color (Glossy)



MicroPRIM Finish



Anchor Bolt Installation for Poles

What's Included Per Pole

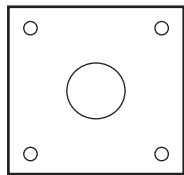
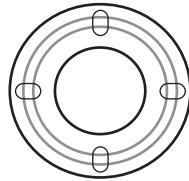
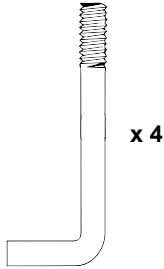

A single anchor bolt template is provided per pole size to be used for the poles on the project.

Anchor bolt template may be round or square dependant upon which pole is being used.

Preferred Pole Installation

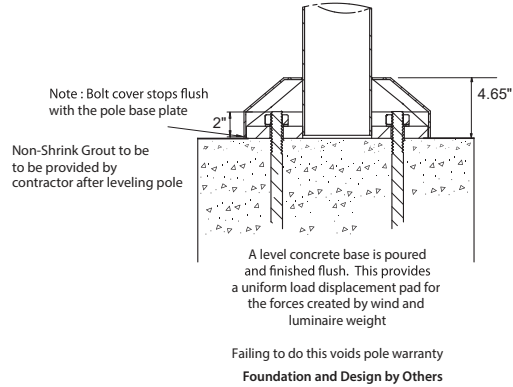

In rare instances where leveling bolts have to be used, it is important that a flush concrete surface is created to mount the pole base plate.
NOTE: When using leveling bolts, bolt projection should be 3.5"

Using Leveling Bolts Option A

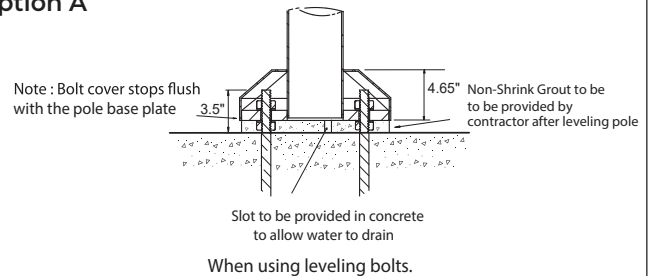

After establishing a level platform the space between the original concrete surface and the pole base should be filled with concrete and finished flush.

This provides a uniform load displacement pad for the forces created by wind and luminaire weight

Foundation and Design by Others

Using Leveling Bolts Option B

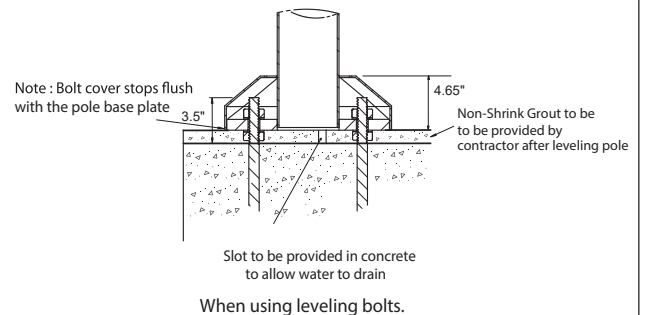

After establishing a level platform the space between the original concrete surface and the pole base should be filled with concrete and finished flush.

This provides a uniform load displacement pad for the forces created by wind and luminaire weight

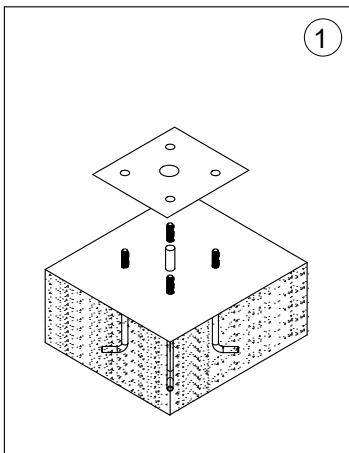

Use anchor bolt template to set anchor bolts into concrete as per civil engineering instructions.

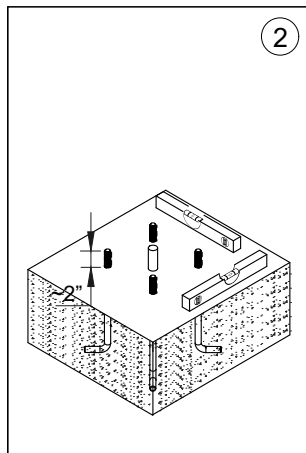

Ensure that the concrete is plumb using a level. Failing to do this will result in pole being uneven or tilted.

Ligman does not provide foundation details. A local engineer that is familiar with the site soil conditions should provide this information.

NOTE:

Ligman does not recommend using leveling Shims for pole installations.

Leveling shims can be provided, contact Ligman for more information.

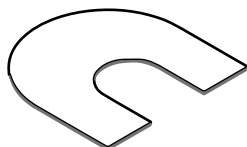

Leveling Shim Example