

UVA-20141

Vancouver 19 Light Column

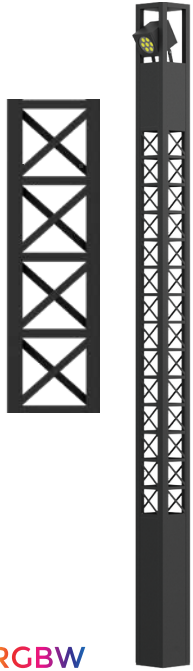

2x33w LED
2x1158 Lumens

IP65
Suitable for wet locations

IK08
Impact Resistant [Vandal Resistant]

Weight 132.3 lbs

Construction

Aluminum
Less than 0.1% copper content – Marine Grade 6060 extruded & LM6 Aluminum High Pressure die casting provides excellent mechanical strength, clean detailed product lines and excellent heat dissipation.

Pre paint
8 step de-grease and phosphate process that includes deoxidizing and etching as well as a zinc and nickel phosphate process before product painting.

Memory Retentive - Silicon Gasket
Provided with special injection molded "fit for purpose" long life high temperature memory retentive silicon gaskets. Maintains the gaskets exact profile and seal over years of use and compression.

Thermal management
LM6 Aluminum is used for its excellent mechanical strength and thermal dissipation properties in low and high ambient temperatures. The superior thermal heat sink design by Ligman used in conjunction with the driver, controls thermals below critical temperature range to ensure maximum luminous flux output, as well as providing long LED service life and ensuring less than 10% lumen depreciation at 50,000 hours.

Surge Suppression
Standard 10kv surge suppressor provided with all fixtures.

BUG Rating
Contact Factory

Finishing
All Ligman products go through an extensive finishing process that includes fettling to improve paint adherence.

Paint
UV Stabilized 4.9Mil thick powder coat paint and baked at 200° C. This process ensures that Ligman products can withstand harsh environments. Rated for use in natatoriums.

Inspired by Nature Finishes
The Inspired by nature Finishing is a unique system of decorative powder coating. Our metal decoration process can easily transform the appearance of metal or aluminum product into a wood grain finish.

This patented technology enables the simulation of wood grain, and even marble or granite finish through the use of decorative powder coating.

The wood grain finish is so realistic that it's almost undistinguishable from real wood, even from a close visual inspection. The system of coating permeates the entire thickness of the coat and as a result, the coating cannot be removed by normal rubbing, chipping, or scratching.

The Coating Process
After pre-treatment the prepared parts are powder coated with a specially formulated polyurethane powder. This powder provides protection against wear, abrasion, impact and corrosion and acts as the relief base color for the finalized metal decoration.

The component is then wrapped with a sheet of non-porous film with the selected decoration pattern printed on it using special high temperature inks.

This printed film transfer is vacuum-sealed to the surface for a complete thermo print and then transferred into a customized oven. The oven transforms the ink into different forms within the paint layer before it becomes solid. Finally, the film is removed, and a vivid timber look on aluminum remains.

Wood grain coating can create beautiful wood-looking products of any sort. There are over 300 combinations of designs currently in use. Wood grains can be made with different colors, designs, etc.

Our powder coatings are certified for indoor and outdoor applications and are backed by a comprehensive warranty. These coatings rise to the highest conceivable standard of performance excellence and design innovation.

- Added Benefits**
- Resistance to salt-acid room, accelerated aging
 - Boiling water, lime and condensed water resistant
 - Anti-Graffiti, Anti-Slip, Anti-Microbial, Anti-Scratch
 - Super durable (UV resistant)
 - TGIC free (non-toxic)

Hardware
Provided Hardware is Marine grade 316 Stainless steel.

Anti Seize Screw Holes
Tapped holes are infused with a special anti seize compound designed to prevent seizure of threaded connections, due to electrolysis from heat, corrosive atmospheres and moisture.

Crystal Clear Low Iron Glass Lens
Provided with tempered, impact resistant crystal clear low iron glass ensuring no green glass tinge.

Optics & LED
Precise optic design provides exceptional light control and precise distribution of light.
LED CRI > 80

Lumen - Maintenance Life
L80 /B10 at 50,000 hours (This means that at least 90% of the LED still achieve 80% of their original flux)

Total urban realm lighting solution. Optional heights, accent spotlights, accessories and decorative lattice panels.

A stylish Dark Sky Compliant square high performance light column with downward light distribution using LED lamps. This light column offers optimal visual comfort through glare control by utilizing a controlled optics designed by Ligman. These columns have a square design providing a unique wide light distribution, offering an architecturally appealing clover leaf pattern on the paving. The internal sides of the supporting pillars are accented by light from the LED.

Color temperature 2700K, 3000K, 3500K and 4000K. The minimalistic shape provides distinctive lighting effects by night and decorative urban effect during the day. Suitable for pedestrian areas, precincts, building surroundings, shopping centers, squares and parks. The Vancouver Column comes standard with a unique waterproof internal driver housing compartment that is situated at the top of the pole to stop water and dust from entering the electrical components.

This fixture is supplied completely wired with powercord and waterproof gland from the driver enclosure to the base of the column to ensure quick trouble-free installation. The Vancouver has a specially designed anchor bolt mounting base that is partially buried below ground level to provide a flush fixture finish with the surface, but maintains the rigidity that is required when installing light columns. This ensures that the anchor bolts are not seen and therefore eliminates the necessity for an anchor bolt cover. (review installation instructions before installing the anchor bolts.)

Custom column heights are available, please specify. Provided with anchor bolts (the root mount kit is an option and is an adder)

Reduced custom wattages can be provided to suit customer requirements. (Specify total watt requirement per fixture) Designed to complement the Vancouver bollard UVA-10001. This product is provided complete with anchor bolts and laser cut steel bolt template.

• **NOTE: For the round version of the Vancouver, please see the [Benton Light Column and Bollard](#)**

RGBW

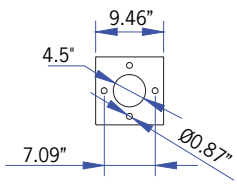
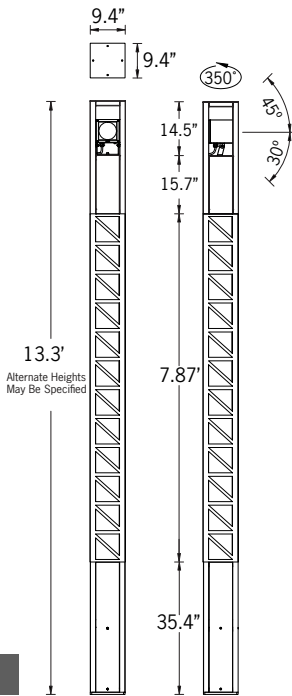

Mounting Detail

Additional Options (Consult Factory For Pricing)

UVA-20141

Vancouver 19 Light Column

PROJECT	<input type="text"/>	DATE	<input type="text"/>
----------------	----------------------	-------------	----------------------

QUANTITY	<input type="text"/>	TYPE	<input type="text"/>	NOTE	<input type="text"/>
-----------------	----------------------	-------------	----------------------	-------------	----------------------

ORDERING EXAMPLE || UVA - 20141 - 2x33w - M - RGBW30 - 02 - 120/277v - Options

UVA-20141	<input type="text"/>	<input type="text"/>	<input type="text"/>	<input type="text"/>	<input type="text"/>
LAMP	BEAM	RGBW COLOR	FINISH COLOR	VOLTAGE	

2x33w LED
2x1158 Lumens

N - Narrow 21°
M - Medium 35°
E - Elliptical 48° x 26°

RGBW30 - Warm White 3200K
RGBW40 - Neutral White 4000K
RGBW65 - Cool White 6850K

01 - BLACK RAL 9011
02 - DARK GREY RAL 7043
03 - WHITE RAL 9003
04 - METALLIC SILVER RAL 9006
05 - MATTE SILVER RAL 9006
06 - LIGMAN BRONZE
07 - CUSTOM RAL



120/277v
Other - Specify

<input type="text"/>	<input type="text"/>	<input type="text"/>
----------------------	----------------------	----------------------

ADDITIONAL OPTIONS

- NAT - Natatorium Rated
- DIM - 0-10v Dimming
- HGT - Custom Height (Specify)
- A20991 - Root Mount Kit
- GFCI - GFCI Box

- A68391 - STICK-DE3
- A64491 - TPC + DMX Controller
- A64591 - POE Connect
- A64691 - TPC + DMX 2
- A64791 - RDM DMX Splitter
- A65191 - TPC Touch Panel
- A65391 - EDN Ethernet Data Node
- A66991 - LPCX Lighting Playback
- A64991 - CLOUD



INSPIRED BY NATURE FINISHES

- SW01 - OAK FINISH
- SW02 - WALNUT FINISH
- SW03 - PINE FINISH
- DF - DOUGLAS FIR FINISH
- CW - CHERRY WOOD FINISH
- NW - NATIONAL WALNUT FINISH
- SU01 - CONCRETE FINISH
- SU02 - SOFTSCAPE FINISH
- SU03 - STONE FINISH
- SU04 - CORTEN FINISH

THERE IS AN ADDITIONAL COST FOR THESE FINISHES

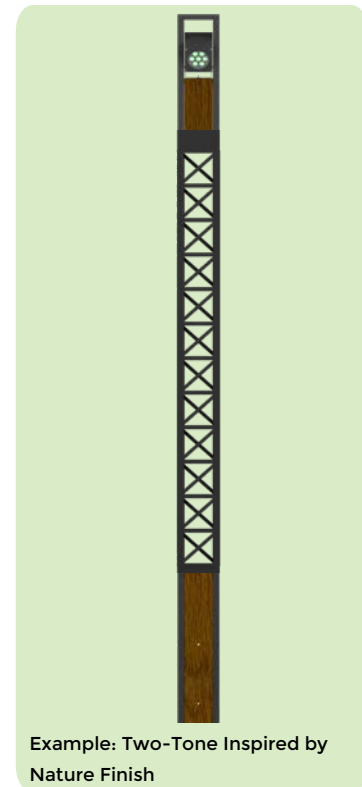

RGBW DMX/RDM Control

RGBW control requires precise communication between lighting fixtures and IP-based systems. To manage Red, Green, Blue, and White diodes effectively, each fixture must be pre-addressed to ensure accurate individual or grouped control.

Ligman's Engineered Approach

Ligman offers a structured, performance-driven methodology for RGBW system design and deployment.

Fixture Addressing

- Default: Fixtures are factory-programmed with the same DMX address unless otherwise specified.
- Issue: Identical addresses cause all fixtures to respond as one—changing colors simultaneously.

Solution: Assign unique DMX addresses to each fixture during programming or via RDM tools to enable independent or grouped control.

Termination Resistors

To prevent signal interference (crosstalk) between fixtures:

- Ligman supplies 120-ohm termination resistors.
- Install inside the last fixture or at its J-Box. – (Resistor will be factory installed on most fixtures, Some will require installation Onsite Depend-ent Upon Fixture and Type.) - Connect between DMX+ and DMX- signal lines.

System Design Guidelines

Fixture Count

- On 3 or More Fixtures: A terminating resistor is installed at the end of the run.
 - On 5 or More Fixtures: Ligman may request additional layout details to validate system integrity.
- Fixtures with Dual DMX Addresses require more DMX channels, reducing the number of fixtures per run. (Refer to technical drawings for specifics.)

- Maximum Distance Without Booster: 984 ft (300 m) from the controller.
- Beyond This Limit: DMX/RDM splitters or boosters are required.

Custom Layouts

For non-standard RGBW configurations, Ligman requires:

- Fixture quantity per run
 - Distance between fixtures
- Total cable length from controller to last fixture

This ensures:

- Reliable DMX signal transmission
 - Proper use of termination resistors and splitters
- Compliance with fixture and distance limitations

STICK-DE3 CONTROLLER CUSTOMER SUPPLY

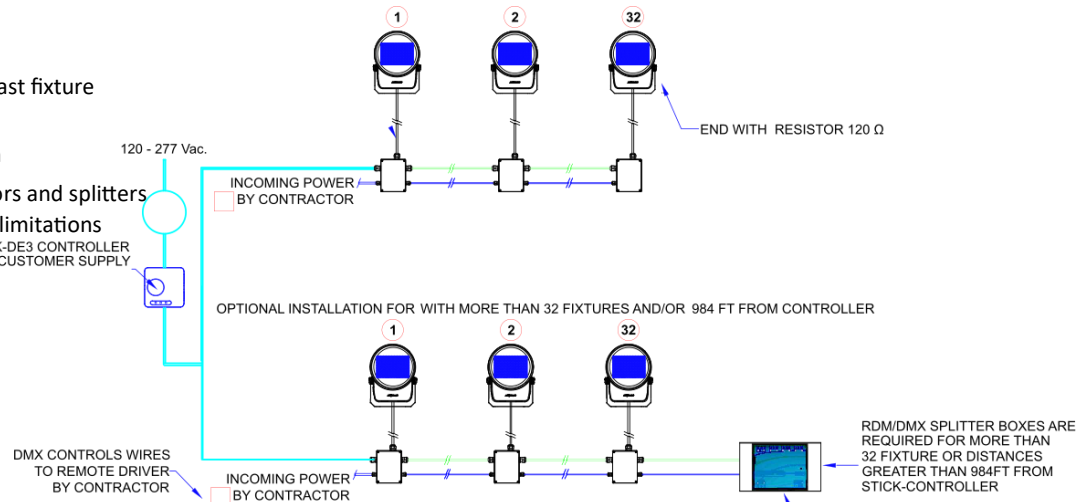

Single Fixture Connection
Or
Final Fixture Connection

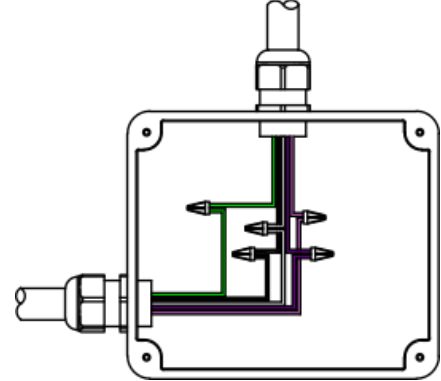

DETAIL WIRE COLORS FOR 5-WIRE CABLE

GREEN	-----	GROUND
BLACK	-----	120/277 HOT
WHITE	-----	NEUTRAL
PURPLE	-----	DMX +
PINK	-----	DMX -

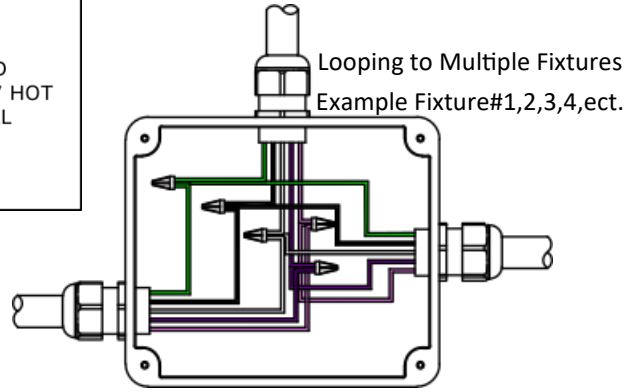



STICK-DE3

The feature rich lighting controller has been designed to provide a control solution for the most demanding of projects, whilst maintaining an easy to use panel of touch sensitive buttons. The controller integrates a graphical color screen allowing scene photos to be displayed. Easily view the selected zone, scene name and design without the need to navigate through complex menus. Change the speed, color and dimmer using the circular palette.

The lighting levels, color and effects can be programmed from a PC, Mac, Android, iPad or iPhone using the included software.



Stick-DE3



A64791

RDM DMX Splitters

The RDM (Remote Device Management) is a 4 port DMX512 Splitter compatible with the RDM standard to provide DMX output to luminaires and other devices. DMX splitters are an essential requirement for most control systems, allowing multiple separate cable runs from a single DMX output and ensuring electrical isolation.

DMX Splitter / Booster - Remote IP65 Box

DMX/RDM Splitter, within an IP65 box with 1 channel output, is a digital signal distributor is used with DMX512-A and ANSI E1.20 RDM. 1-port, DMX/RDM isolated splitter engineered to take any architectural, commercial, or entertainment project to the next level. Multiple DMX/RDM Splitter can be chained together to create as many outputs as you need.

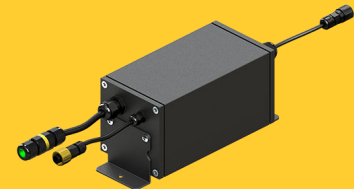

RDM - DMX Repeater

The RDM (Remote Device Management) is a 4 port DMX512 Splitter compatible with the RDM standard to provide DMX output to luminaires and other devices. DMX splitters are an essential requirement for most control systems, allowing multiple separate cable runs from a single DMX output and ensuring electrical isolation.

Vancouver Product Family

Vancouver 1

- UVA-20001-70w-6350lm [9.4"x9.4"-14.7]
- UVA-20001-60w-6084lm [9.4"x9.4"-14.7]
- UVA-20001-50w-5576lm [9.4"x9.4"-14.7]
- UVA-20001-40w-2969lm [9.4"x9.4"-14.7]

Vancouver 2

- UVA-20011-20w-1414lm [6.3"x6.3"-9.8]

Vancouver 3

- UVA-10001-21w-1270lm [9.4"x9.4"-39.3]

Vancouver 4

- UVA-10011-15w-837lm [6.3"x6.3"-39.3]

Vancouver 5

- UVA-20021-39/21w-1336/1673lm [9.4"x9.4"-13.3]
- UVA-20022-39/2x21w-1336/2x1673lm [9.4"x9.4"-14.5]
- UVA-20023-39/3x21w-1336/3x1673lm [9.4"x9.4"-15.7]

Vancouver 6

- UVA-20031-39/21w-1167/1673lm [9.4"x9.4"-13.3]
- UVA-20032-39/2x21w-1167/2x1673lm [9.4"x9.4"-14.5]
- UVA-20033-39/3x21w-1167/3x1673lm [9.4"x9.4"-15.7]

Vancouver 7

- UVA-20041-39/21w-1670/1673lm [9.4"x9.4"-13.3]
- UVA-20042-39/2x21w-1670/2x1673lm [9.4"x9.4"-14.5]
- UVA-20043-39/3x21w-1670/3x1673lm [9.4"x9.4"-15.7]

Vancouver 8

- UVA-20051-40w-1336lm [9.4"x9.4"-12.1]

Vancouver 9

- UVA-20061-40w-1167lm [9.4"x9.4"-12.1]

Vancouver 10

- UVA-20071-40w-1670lm [9.4"x9.4"-12.1]

Vancouver 11

- UVA-10021-21w-570lm [9.4"x9.4"-39.3]

Vancouver 12

- UVA-10031-21w-490lm [9.4"x9.4"-39.3]

Vancouver 13

- UVA-10041-21w-704lm [9.4"x9.4"-39.3]

Vancouver 14

- UVA-70001-8w-331lm [6.3"x6.3"-15.7]

Vancouver 15

- UVA-70011-21w-815lm [9.4"x9.4"-15.7]

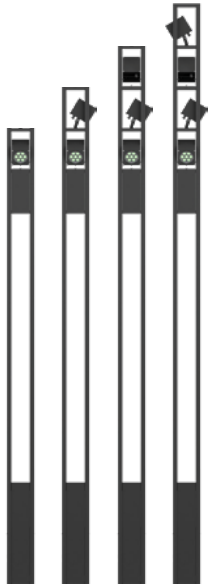

Vancouver 16

- UVA-20111-33w-1429lm [9.4"x9.4"-13.3']
- UVA-20112-66w-4287lm [9.4"x9.4"-14.5']
- UVA-20113-99w-5716lm [9.4"x9.4"-15.7']
- UVA-20114-132w-7145lm [9.4"x9.4"-17']

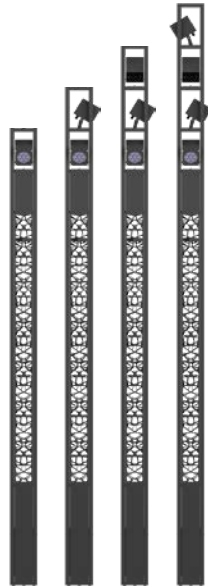

Vancouver 17

- UVA-20121-33w-2858lm [9.4"x9.4"-13.3']
- UVA-20122-66w-4287lm [9.4"x9.4"-14.5']
- UVA-20123-99w-5716lm [9.4"x9.4"-15.7']
- UVA-20124-132w-7145lm [9.4"x9.4"-17']

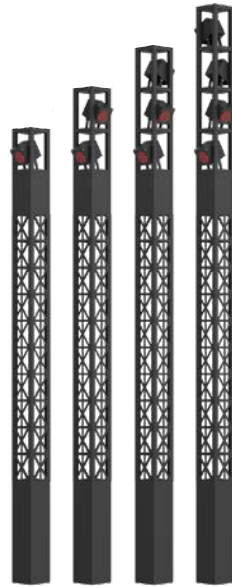

Vancouver 18

- UVA-20131-33w-2858lm [9.4"x9.4"-13.3']
- UVA-20132-66w-4287lm [9.4"x9.4"-14.5']
- UVA-20133-99w-5716lm [9.4"x9.4"-15.7']
- UVA-20134-132w-7145lm [9.4"x9.4"-17']

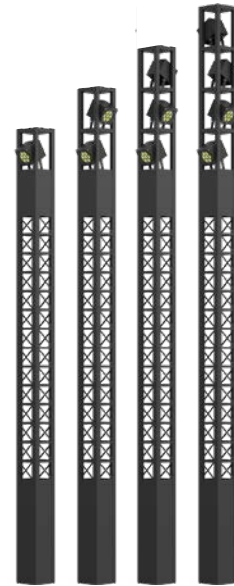

Vancouver 19

- UVA-20141-33w-2858lm [9.4"x9.4"-13.3']
- UVA-20142-66w-4287lm [9.4"x9.4"-14.5']
- UVA-20143-99w-5716lm [9.4"x9.4"-15.7']
- UVA-20144-132w-7145lm [9.4"x9.4"-17']



Vancouver 20

- UVA-20151-33w-1429lm [9.4"x9.4"-12.1']

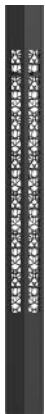

Vancouver 21

- UVA-20161-33w-1429lm [9.4"x9.4"-12.1']



Vancouver 22

- UVA-20171-33w-1429lm [9.4"x9.4"-12.1']



Vancouver 23

- UVA-20181-33w-1429lm [9.4"x9.4"-12.1']



Vancouver 24

- UVA-30001-8w-331lm [6.3"x6.3"-15.7"]



Vancouver 25

- UVA-30011-21w-570lm [6.3"x6.3"-23.6"]



Vancouver 26

- UVA-30012-21w-490lm [6.3"x6.3"-23.6"]



Vancouver 27

- UVA-30013-21w-740lm [6.3"x6.3"-23.6"]



Vancouver 28

- UVA-30021-39w-1336lm [9.4"x9.4"-39.3']
- UVA-30031-33w RGBW-429lm [9.4"x9.4"-39.3']



Vancouver 29

- UVA-30022-39w-1167lm [9.4"x9.4"-39.3']
- UVA-30032-33w RGBW-1158lm [9.4"x9.4"-39.3']



Vancouver 30

- UVA-30023-39w-1670lm [9.4"x9.4"-39.3']
- UVA-30033-33w RGBW-439lm [9.4"x9.4"-39.3']



Vancouver 31

• UVA-10101-7w-200lm [4.7' x 4.7' - 23.6"]



Vancouver 33

• UVA-10051-15w-1083lm [6.3' x 6.3' - 39.3"]



Vancouver 34

• UVA-10061-21w-1571lm [9.4' x 9.4' - 39.3"]



Vancouver 35

• UVA-10071-21w-1571lm [9.4' x 9.4' - 39.3"]



Vancouver 36

• UVA-10072-21w-1571lm [9.4' x 9.4' - 39.3"]



Vancouver 37

• UVA-10073-21w-1571lm [9.4' x 9.4' - 39.3"]



Vancouver 38

• UVA-10141-8w-95lm [4.7' x 4.7' - 23.6"]



Vancouver 39

• UVA-10151-15w-418lm [6.3' x 6.3' - 39.3"]



Vancouver 40

• UVA-10161-21w-635lm [9.4' x 9.4' - 39.3"]



Vancouver 41

• UVA-20191-20w-1326lm [6.3' x 6.3' - 9.8"]



Vancouver 42

• UVA-20201-40w-2969lm [9.4' x 9.4' - 14.7"]



Vancouver 43

• UVA-20211-39/21w-2781/1688lm [9.4'x9.4"-13.3"]



Vancouver 44

• UVA-20212-39/2x21w-2781/2x1688lm [9.4'x9.4"-14.5"]



Vancouver 45

• UVA-20213-39/3x21w-2781/3x1688lm [9.4'x9.4"-15.7"]



Vancouver 46

• UVA-20221-39/21w-4469/1688lm [9.4'x9.4"-13.3"]



Vancouver 47

• UVA-20221-39/2x21w-4469/2x1688lm [9.4"x9.4"-14.5"]



Vancouver 48

• UVA-20223-39/3x21w-4469/3x1688lm [9.4"x9.4"-15.7"]



Vancouver 49

• UVA-20231-39/21w-2781/1688lm [9.4"x9.4"-13.3"]



Vancouver 50

• UVA-20232-39/2x21w-2781/2x1688lm [9.4"x9.4"-14.5"]



Vancouver 51

• UVA-20233-39/2x21w-2781/2x1688lm [9.4"x9.4"-15.7"]



Vancouver 52

• UVA-20241-40w-2781lm [9.4"x9.4"-12"]



Vancouver 53

• UVA-20242-40w-2781lm [9.4"x9.4"-12"]

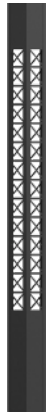

Vancouver 54

• UVA-20243-40w-2781lm [9.4"x9.4"-12"]



Vancouver 55

• UVA-20251-21w-710lm [6.3"x6.3"-9.8"]



Vancouver 56

• UVA-20261-40w-1485lm [9.4"x9.4"-14.7"]

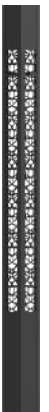

Vancouver 60

• UVA-20281-76w-4140lm [9.4"x9.4"-12"]



Vancouver 61

• UVA-20282-76w-4140lm [9.4"x9.4"-12"]



Vancouver 62

• UVA-20283-76w-4140lm [9.4"x9.4"-12"]



Vancouver 63

• UVA-70021-13w-437lm [6.3"x6.3"-15.7"]

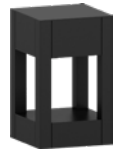

Vancouver 64

• UVA-70031-20w-1362lm [9.4"x9.4"-15.7"]



Vancouver 65

• UVA-70041-8w-165lm [6.3'x6.3'-15.7']



Vancouver 66

• UVA-70051-21w-410lm [9.4'x9.4'-15.7']



Vancouver 67

• UVA-30041-20w-1326lm [6.3'x6.3'-23.6']



Vancouver 68

• UVA-30042-20w-1326lm [6.3'x6.3'-23.6']



Vancouver 69

• UVA-30043-20w-1326lm [6.3'x6.3'-23.6']



Vancouver 70

• UVA-30051-40w-2781lm [9.4'x9.4'-39.3']



Vancouver 71

• UVA-30052-40w-2781lm [9.4'x9.4'-39.3']



Vancouver 72

• UVA-30053-40w-2781lm [9.4'x9.4'-39.3']