

UVK-90071

Vekter Street & Area Light

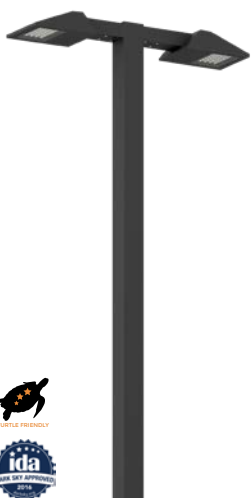

2x37w LED
2x5143 Lumens

IP65
Suitable for wet locations

IK08
Impact Resistant [Vandal Resistant]

EPA - Contact Factory

Weight - 47 lbs

POLE NOT INCLUDED



Construction

Aluminum

Less than 0.1% copper content – Marine Grade 6060 extruded & LM6 Aluminum High Pressure die casting provides excellent mechanical strength, clean detailed product lines and excellent heat dissipation.

Pre paint

8 step degrease and phosphate process that includes deoxidizing and etching as well as a zinc and nickel phosphate process before product painting.

Memory Retentive -Silicon Gasket

Provided with special injection molded “fit for purpose” long life high temperature memory retentive silicon gaskets. Maintains the gaskets exact profile and seal over years of use and compression.

Thermal management

LM6 Aluminum is used for its excellent mechanical strength and thermal dissipation properties in low and high ambient temperatures. The superior thermal heat sink design by Ligman used in conjunction with the driver, controls thermals below critical temperature range to ensure maximum luminous flux output, as well as providing long LED service life and ensuring less than 10% lumen depreciation at 50,000 hours.

Surge Suppression

Standard 10kv surge suppressor provided with all fixtures.

BUG Rating

Contact Factory

Finishing

All Ligman products go through an extensive finishing process that includes fettling to improve paint adherence.

Paint

UV Stabilized 4.9Mil thick powder coat paint and baked at 200 Deg C.

This process ensures that Ligman products can withstand harsh environments.

Rated for use in natatoriums.

Hardware

Provided Hardware is Marine grade 316 Stainless steel.

Anti Seize Screw Holes

Tapped holes are infused with a special anti seize compound designed to prevent seizure of threaded connections, due to electrolysis from heat, corrosive atmospheres and moisture.

Crystal Clear Low Iron Glass Lens

Provided with tempered, impact resistant crystal clear low iron glass ensuring no green glass tinge.

Optics & LED

Precise optic design provides exceptional light control and precise distribution of light. LED CRI > 80

Lumen - Maintenance Life

L80 /B10 at 50,000 hours (This means that at least 90% of the LED still achieve 80% of their original flux)

Modern, contemporary post top

Beautiful modern urban post top in either single or twin arm configuration, offering powerful street lighting and beam performance choices.

A modern style die-cast square arm aluminum post top decorative luminaire with excellent downward light distribution that complies with dark sky requirements. Outstanding visual appeal and precision optical system gives very low glare rating, whilst reducing light pollution. This luminaire is available in two configurations, namely a single or double arm option to suit aesthetic design requirements.

The Vekter is unique as it is available with Type I, II, III, IV & V light distribution options that facilitates wider spacing and even light distribution between the light fixtures. Wide spacings can be achieved using a type II optic with uniformity that complies to path of egress requirements. This provides higher energy saving and reduced installation costs. The Vekter can be manufactured using different type beam optics to achieve custom distribution, e.g using type II and type IV optics inside the same luminaire.

Color temperature 2700K, 3000K, 3500K and 4000K, LED CRI >80 and life time 50,000 Hours. Stainless steel screws. Durable silicone rubber gasket and clear tempered glass. Powder paint with high corrosion resistance with chemical chromatised protection. Integral control gear. Customer specific wattages can be provided, please contact the factory for more information.

Available with a selection of dimmable integral electronic drivers, as well as a provision to install wireless lighting controls to integrate with building management systems.

To meet International Dark Sky criteria, 3000k or warmer LEDs must be selected and luminaire fix mounted (+/- 15° allowable to permit leveling).

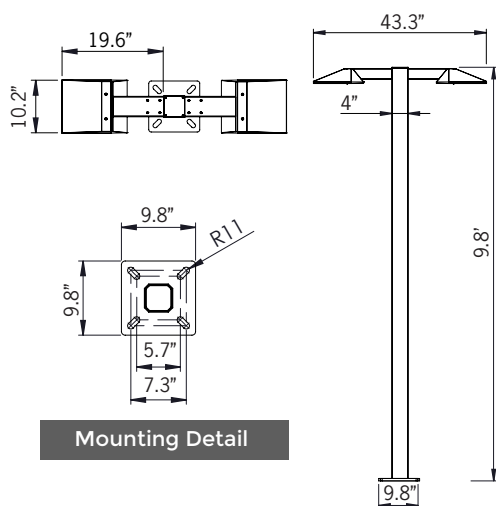

Mounting Detail



Ligman's micro Variable Optical System provides the ability to interchange, mix & rotate optics to provide specific light distributions for optimized spacing and uniformity.

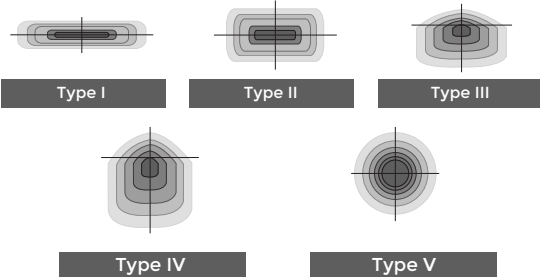

The variable optic system allows for the designer to create hybrid distributions for precise lighting requirements.

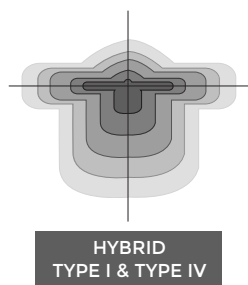

UVK-90071

Vekter Street & Area Light



PROJECT		DATE	
----------------	--	-------------	--

QUANTITY		TYPE		NOTE	
-----------------	--	-------------	--	-------------	--

ORDERING EXAMPLE || UVK - 90071 - 2x37w - T2 - W30 - 02 - 120/277v - Options

UVK-90071					
LAMP	BEAM	LED COLOR	FINISH COLOR	VOLTAGE	
2x37w LED 2x5143 Lumens	T1 - Type I Distribution T2 - Type II Distribution T3 - Type III Distribution T4 - Type IV Distribution T5 - Type V Distribution ME - Type ME Distribution	W27 - 2700K W30 - 3000K W35 - 3500K W40 - 4000K	01 - BLACK RAL 9011 02 - DARK GREY RAL 7043 03 - WHITE RAL 9003 04 - METALLIC SILVER RAL 9006 05 - MATTE SILVER RAL 9006 06 - LIGMAN BRONZE 07 - CUSTOM RAL	120/277v Other - Specify	

--	--	--

ADDITIONAL OPTIONS

- | | |
|----------------------------------|---|
| DIM - 0-10v Dimming | HSS - House Side Shield |
| NAT - Natatorium Rated | F - Frosted Lens |
| WLC - Wireless Lighting Controls | OS - FSP Occupancy Sensor [See last page] |
| GFCI - GFCI Box | FSIR - Occupancy Sensor Remote Programmer [See last page] |
| AMB - Turtle Friendly Amber LED | |

CITY OF FLAGSTAFF & TURTLE FRIENDLY COMPLIANT

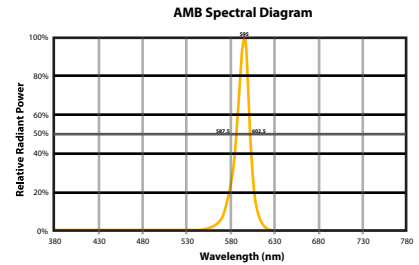

Narrow-Spectrum Amber LEDs
Peak wavelength between 585 & 595 nanometers and a full width of 50% power no greater than 15 nanometers.



Vekter Product Family



Vekter 1

- UVK-30001-20w-2446lm
- UVK-30002-28w-3330lm



Vekter 2

- UVK-30003-37w-5143lm
- UVK-30004-54w-6954lm



Vekter 3

- UVK-10001-20w-2473lm
- UVK-10002-28w-3330lm



Vekter 4

- UVK-10011-2x20w-2x2473lm
- UVK-10012-2x28w-2x3330lm



Vekter 5

- UVK-90001-37w-5143lm
- UVK-90002-54w-6954lm



Vekter 6

- UVK-90011-2x37w-2x5143lm
- UVK-90012-2x54w-2x6954lm



Vekter 7

- UVK-30011-20w-2473lm
- UVK-30012-28w-3330lm



Vekter 8

- UVK-30031-37w-5143lm
- UVK-30032-54w-6954lm



Vekter 9

- UVK-30021-20w-2473lm
- UVK-30022-28w-3330lm



Vekter 10

- UVK-30041-37w-5143lm
- UVK-30042-54w-6954lm



Vekter 11 - 13.1'

- UVK-20001-20w-2473lm
- UVK-20002-28w-3330lm



Vekter 12 - 13.1'

- UVK-20003-37w-5143lm
- UVK-20004-54w-6954lm



Vekter 13 - 13.1'

- UVK-20011-2x20w-2x2473lm
- UVK-20012-2x28w-2x3330lm



Vekter 14 - 13.1'

- UVK-20013-2x37w-2x5143lm
- UVK-20014-2x54w-2x6954lm



Vekter 15

- UVK-90021-4x20w-4x2473lm
- UVK-90022-4x28w-4x3330lm



Vekter 16

- UVK-90031-4x37w-4x5143lm
- UVK-90032-4x54w-4x6954lm



Vekter 17 - 19.6'

- UVK-20021-20w-2473lm
- UVK-20022-28w-3330lm



Vekter 18 - 19.6'

- UVK-20023-37w-5143lm
- UVK-20024-54w-6954lm



Vekter 19 - 19.6'

- UVK-20031-2x20w-2x2473lm
- UVK-20032-2x28w-2x3330lm



Vekter 20 - 19.6'

- UVK-20033-2x37w-2x5143lm
- UVK-20034-2x54w-2x6954lm

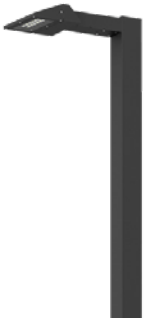

Vekter 25

- UVK-90041-20w-2473lm
- UVK-90042-28w-3330lm



Vekter 26

- UVK-90051-2x20w-2x2473lm
- UVK-90052-2x28w-2x3330lm



Vekter 27

- UVK-90061-37w-5143lm
- UVK-90062-54w-6954lm



Vekter 28

- UVK-90071-2x37w-2x5143lm
- UVK-90072-2x54w-2x6954lm

HIGH/LOW/OFF PIR OUTDOOR PHOTO/MOTION SENSOR IP66 - Integrated photocell

Ligman provides integrated photocell control using the wattstopper legrand FSP-211B. These units are installed inside the fixture housing with only the external lenses being visible



FSP-211B

Dimensions of Lens Options

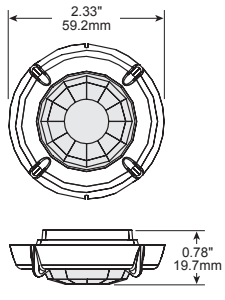

FSP-L2 dimensions

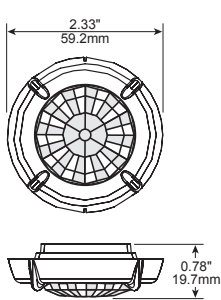

FSP-L3 dimensions

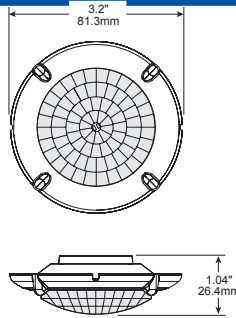

FSP-L7 dimensions

Product Overview

The FSP-221B is a family of passive infrared (PIR) outdoor sensors that raise or lower the electric lighting level to high, low or off based on motion and/or daylight contribution. Typically, once the sensor stops detecting movement and the time delay elapses, lights will first fade to low mode, and eventually switch off. When motion is detected, the sensor ramps the light level to high mode unless the daylight contribution is sufficient.

The integral photocell can also switch the lights on and off for dusk to dawn control, so that lighting remains on overnight even without motion detection.

The sensors control 0-10VDC or nondimming LED drivers or ballasts.

The low voltage FSP-201B may be used with dim-to-off drivers or ballasts.

Initial setup and subsequent sensor adjustments are made using a Wireless Handheld Configuration Tool (FSIR-100). This tool enables adjustment of sensor parameters including high/low mode, sensitivity, time delay, cut off and more.

The FSIR-100 can read current parameter settings, and stores up to six sensor parameter profiles to speed commissioning of multiple sensors.

Coverage

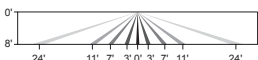
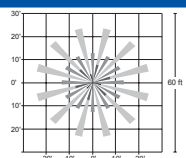

FSP-L2 top and side coverage patterns

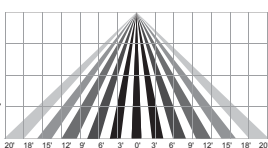
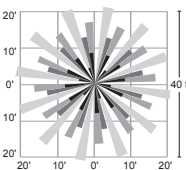

FSP-L3 top and side coverage patterns

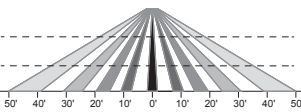
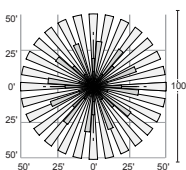

FSP-L7 top and side coverage patterns

Models

- FSP-211B, 120-277 VAC
- FSP-221B, 100-347 VAC

Specifications and Features



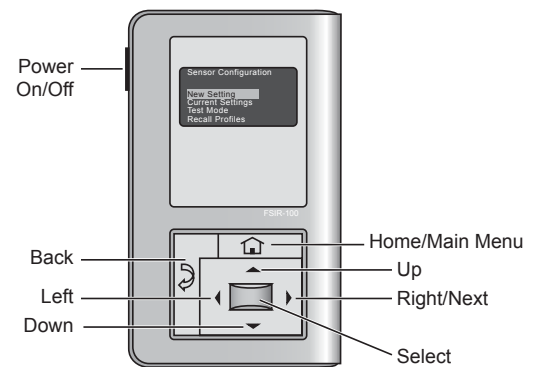

- Three interchangeable lenses for mounting between 8' and 40'
- Remote setup and adjustment with handheld wireless configuration tool
- Adjustable high and low modes (high: 0 to 10V, low: off, 0 to 9.8V)
- Adjustable time delay (30 seconds, 1 to 30 minutes)
- Adjustable cut off delay (none, 1 to 59 minutes, 1 to 5 hours)
- Adjustable sensitivity/service mode (low, med, max; on-fix, off-fix)
- Adjustable setpoints: hold off setpoint (none, 1 to 250 fc, auto); photocell on/off setpoint (1 to 250 fc)
- Adjustable ramp and fade times (1 to 60 seconds)
- Operating temperature: -40°F to +167°F (-40°C to +75°C)
- IP66 rated
- Five year warranty

Factory Defaults

- High mode: 10V
- Low mode: 1V
- Time delay: 5 minutes
- Cut off: 1 hour
- Setpoint: Disabled
- Sensitivity: Max
- Ramp up time: Disabled
- Fade down time: Disabled
- Photocell On/Off: Disabled



The **FSIR-100** is a convenient handheld remote tool for sensor setting. Adjustable settings can be changed as needed for specific applications.

Catalog #	Color	Description
 FSP-L2	White/Grey/Black/Brown <small>The Trim color option will be selected to closest match fixture color. e.g. (Matte silver fixture - grey trim)</small>	360° lens, maximum coverage 48' diameter from 8' height
 FSP-L3	White/Grey/Black/Brown <small>The Trim color option will be selected to closest match fixture color. e.g. (Matte silver fixture - grey trim)</small>	360° lens, maximum coverage 40' diameter from 20' height
 FSP-L7	White/Grey/Black/Brown <small>The Trim color option will be selected to closest match fixture color. e.g. (Matte silver fixture - grey trim)</small>	360° lens, maximum coverage 100' diameter from 40' height
 FSIR-100	Black	Remote Handheld Configuration Tool