

UFOR-30091

Forrey 35 Wall Mount Opal Lens

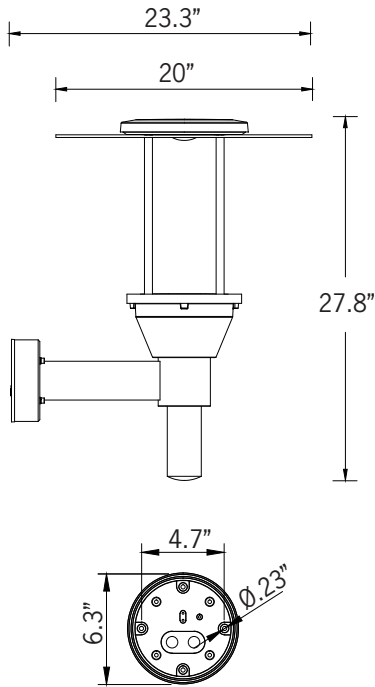

48w LED 4197 Lumens
IP65 • Suitable For Wet Locations
IK08 • Impact Resistant (Vandal Resistant)
Weight 28.6 lbs



Mounting Detail

Construction

Aluminum

Less than 0.1% copper content – Marine Grade 6060 extruded & LM6 Aluminum High Pressure die casting provides excellent mechanical strength, clean detailed product lines and excellent heat dissipation.

Pre paint

8 step degrease and phosphate process that includes deoxidizing and etching as well as a zinc and nickel phosphate process before product painting.

Memory Retentive -Silicon Gasket

Provided with special injection molded "fit for purpose" long life high temperature memory retentive silicon gaskets. Maintains the gaskets exact profile and seal over years of use and compression.

Thermal management

LM6 Aluminum is used for its excellent mechanical strength and thermal dissipation properties in low and high ambient temperatures. The superior thermal heat sink design by Ligman used in conjunction with the driver, controls thermals below critical temperature range to ensure maximum luminous flux output, as well as providing long LED service life and ensuring less than 10% lumen depreciation at 50,000 hours.

Surge Suppression

Standard 10kv surge suppressor provided with all fixtures.

BUG Rating

Contact Factory

Finishing

All Ligman products go through an extensive finishing process that includes fettling to improve paint adherence.

Paint

UV Stabilized 4.9Mil thick powder coat paint and baked at 200 Deg C. This process ensures that Ligman products can withstand harsh environments. Rated for use in natatoriums.

Inspired by Nature Finishes

The Inspired by nature Finishing is a unique system of decorative powder coating. Our metal decoration process can easily transform the appearance of metal or aluminum product into a wood grain finish.

This patented technology enables the simulation of wood grain, and even marble or granite finish through the use of decorative powder coating.

The wood grain finish is so realistic that it's almost undistinguishable from real wood, even from a close visual inspection. The system of coating permeates the entire thickness of the coat and as a result, the coating cannot be removed by normal rubbing, chipping, or scratching.

The Coating Process

After pre-treatment the prepared parts are powder coated with a specially formulated polyurethane powder. This powder provides protection against wear, abrasion, impact and corrosion and acts as the relief base color for the finalized metal decoration.

The component is then wrapped with a sheet of non-porous film with the selected decoration pattern printed on it using special high temperature inks.

This printed film transfer is vacuum-sealed to the surface for a complete thermo print and then transferred into a customized oven. The oven transforms the ink into different forms within the paint layer before it becomes solid. Finally, the film is removed, and a vivid timber look on aluminum remains.

Wood grain coating can create beautiful wood-looking products of any sort. There are over 300 combinations of designs currently in use. Wood grains can be made with different colors, designs, etc.

Our powder coatings are certified for indoor and outdoor applications and are backed by a comprehensive warranty. These coatings rise to the highest conceivable standard of performance excellence and design innovation.

Added Benefits

- Resistance to salt-acid room, accelerated aging
- Boiling water, lime and condensed water resistant
- Anti-Graffiti, Anti-Slip, Anti-Microbial, Anti-Scratch
- Super durable (UV resistant)
- TGIC free (non-toxic)

Hardware

Provided Hardware is Marine grade 316 Stainless steel.

Anti Seize Screw Holes

Tapped holes are infused with a special anti seize compound designed to prevent seizure of threaded connections, due to electrolysis from heat, corrosive atmospheres and moisture.

High Impact Acrylic Lens

Manufactured with Ultra High Impact, Naturally UV Stabilized Injection Molded Acrylic.

Optics & LED

Precise optic design provides exceptional light control and precise distribution of light.
LED CRI > 80

Lumen - Maintenance Life

L80 /B10 at 50,000 hours (This means that at least 90% of the LED still achieve 80% of their original flux)

High efficiency meets the classic for factor. Complete range of decorative lighting solutions, offering multiple beam distributions and superior efficacies.

A decorative range of wall mount luminaires designed to complement the Forrey pendant, bollard and post top with options of having no lens or a high impact UV stabilized opal lens. This decorative lantern provides a symmetrical light distribution using high output LEDs. Designed for lighting entrances, retail outlets, malls and showrooms.

Color temperature 2700K, 3000K, 3500K and 4000K, LED CRI >80 and life time 50,000 Hours. High pressure die-cast marine grade LM6 aluminum body that is pre-treated with a nickel and zinc phosphate and then powder coated with a 4.9mil thick paint finish ensuring high corrosion resistance. Marine grade 316 stainless steel fasteners.

For No Lens, see UFOR-30081

UFOR-30091

Forrey 35 Wall Mount Opal Lens

PROJECT	<input type="text"/>	DATE	<input type="text"/>
----------------	----------------------	-------------	----------------------

QUANTITY	<input type="text"/>	TYPE	<input type="text"/>	NOTE	<input type="text"/>
-----------------	----------------------	-------------	----------------------	-------------	----------------------

ORDERING EXAMPLE || UFOR - 30091 - 48w - W30 - 02 - 120/277v - Options

UFOR-30091	<input type="text"/>	<input type="text"/>	<input type="text"/>	<input type="text"/>
LAMP	LED COLOR	FINISH COLOR	VOLTAGE	
48w LED 4197 Lumens	W27 - 2700K W30 - 3000K W35 - 3500K W40 - 4000K	01 - BLACK RAL 9011 02 - DARK GREY RAL 7043 03 - WHITE RAL 9003 04 - METALLIC SILVER RAL 9006 05 - MATTE SILVER RAL 9006 06 - LIGMAN BRONZE 07 - CUSTOM RAL	120/277v Other - Specify	

<input type="text"/>	<input type="text"/>	<input type="text"/>
----------------------	----------------------	----------------------

ADDITIONAL OPTIONS

- DIM - 0-10v Dimming
- NAT - Natatorium Rated
- C - Clear Lens

INSPIRED BY NATURE FINISHES

- SW01 - OAK FINISH
- SW02 - WALNUT FINISH
- SW03 - PINE FINISH
- DF - DOUGLAS FIR FINISH
- CW - CHERRY WOOD FINISH
- NW - NATIONAL WALNUT FINISH
- SU01 - CONCRETE FINISH
- SU02 - SOFTSCAPE FINISH
- SU03 - STONE FINISH
- SU04 - CORTEN FINISH

THERE IS AN ADDITIONAL COST FOR THESE FINISHES

More Custom Finishes Available Upon Request

Consult factory for pricing and lead times

 Oak	 Cherry	 Beech	 Carbon
 Walnut	 Chestnut	 Bamboo	 Galvanized
 Pine	 Mahogany	 Birch	 Steel



Example: Inspired by Nature Finish



Forrey Product Family



Forrey 1 Ø6.3

- UFOR-10001-48w COB-4755lm-32.4"
- UFOR-10011-48w COB-4755lm-42.8"
- UFOR-10021-50w LED-4340lm-32.4"
- UFOR-10031-50w LED-4340lm-42.8"



Forrey 2 Ø6.3"

- UFOR-10002-48w COB-3527lm-32.4"
- UFOR-10012-48w COB-3527lm-42.8"
- UFOR-10022-50w LED-3361lm-32.4"
- UFOR-10032-50w LED-3361lm-42.8"



Forrey 3 Ø7.3"

- UFOR-10081-51w COB-4755lm-34.3"
- UFOR-10091-48w COB-4755lm-46.3"
- UFOR-10101-50w LED-4340lm-34.3"
- UFOR-10111-50w LED-4340lm-46.3"



Forrey 4 Ø7.3"

- UFOR-10082-48w COB-3527lm-34.3"
- UFOR-10092-48w COB-3527lm-34.3"
- UFOR-10102-50w LED-3361lm-34.3"
- UFOR-10112-50w LED-3361lm-34.3"



Forrey 5 Ø6.3

- UFOR-10041-48w COB-4780lm-32.4"
- UFOR-10051-48w COB-4780lm-42.8"
- UFOR-10061-50w LED-4556lm-32.4"
- UFOR-10071-50w LED-4556lm-42.8"



Forrey 6 Ø6.3

- UFOR-10042-48w COB-3711lm-42.8"
- UFOR-10062-50w LED-3526lm-42.8"
- UFOR-10052-48w COB-3711lm-42.8"
- UFOR-10072-50w LED-3526lm-42.8"



Forrey 8 Ø7.3"

- UFOR-10122-48w COB-3711lm-46.3"
- UFOR-10132-48w COB-3711lm-46.3"
- UFOR-10142-50w LED-3526lm-34.3"
- UFOR-10152-50w LED-3526lm-46.3"



Forrey 9 Ø26"

- UFOR-20001-48w COB-4813m
- UFOR-20011-50w LED-4197lm



Forrey 10 Ø26"

- UFOR-20002-48w COB-3749m
- UFOR-20012-50w LED-3275lm



Forrey 11 Ø34.6"

- UFOR-20041-70w COB-7522lm
- UFOR-20051-60w LED-4553lm



Forrey 12 Ø34.6"

- UFOR-20042-70w COB-6603lm
- UFOR-20052-60w LED-4053lm



Forrey 13 Ø12.5"

- UFOR-20021-48w COB-4780lm
- UFOR-20031-50w LED-4556lm



Forrey 14 Ø9.8"

- UFOR-20022-48w COB-371lm
- UFOR-20032-50w LED-3526lm



Forrey 15 Ø12.5"

- UFOR-20061-70w COB-8415lm
- UFOR-20071-60w LED-4553lm



Forrey 16 Ø12.5"

- UFOR-20061-70w COB-8415lm
- UFOR-20071-60w LED-4553lm



Forrey 17 Ø26"

- UFOR-30001-48w COB-4813lm
- UFOR-30011-50w LED-4197lm



Forrey 18 Ø26"

- UFOR-30002-48w COB-3749lm
- UFOR-30012-50w LED-3275lm



Forrey 19 Ø34.6"

- UFOR-30041-70w COB-7522lm
- UFOR-30051-60w LED-4553lm



Forrey 20 Ø34.6"

- UFOR-30042-70w COB-6603lm
- UFOR-30052-60w LED-4053lm



Forrey 21 Ø9.8"

- UFOR-30021-48w COB-4780lm
- UFOR-30031-50w LED-4556lm



Forrey 22 Ø6.3

- UFOR-30022-48w COB-3711lm
- UFOR-30032-50w LED-3526lm



Forrey 23 Ø12.5"

- UFOR-30061-70w COB-8415lm
- UFOR-30071-60w LED-4553lm



Forrey 24 Ø12.5"

- UFOR-30062-70w COB-6603lm
- UFOR-30072-60w LED-4053lm



Forrey 25 Ø26"

- UFOR-95001-48w COB-4813lm
- UFOR-95011-50w LED-4197lm



Forrey 26 Ø6.3

- UFOR-95002-48w COB-3749lm
- UFOR-95012-50w LED-3275lm



Forrey 27 Ø34.6"

- UFOR-95041-70w COB-7522lm
- UFOR-95051-60w LED-4553lm



Forrey 28 Ø34.6"

- UFOR-95042-70w COB-6603lm
- UFOR-95052-60w LED-4053lm



Forrey 29 Ø9.8"/8.8"

- UFOR-95021-48w COB-4780lm
- UFOR-95031-50w LED-4556lm



Forrey 30 Ø9.8"/8.8"

- UFOR-95022-48w COB-3711lm
- UFOR-95032-50w LED-3526lm



Forrey 31 Ø12.5"/10.5"

- UFOR-95061-70w COB-8415lm
- UFOR-95071-60w LED-4553lm



Forrey 32 Ø12.5"/10.5"

- UFOR-95062-70w COB-6603lm
- UFOR-95072-60w LED-4053lm



Forrey 33 Ø20"

- UFOR-30081-50w LED-4813lm



Forrey 34 Ø20"

- UFOR-30082-50w LED-3749lm



Forrey 35 Ø20"

- UFOR-30091-48w LED-4197lm



Forrey 36 Ø20"

- UFOR-30092-48w LED-3275lm